

microlab[®]

microlab[®]

Art For The Ear



SOLO7C
User's Manual

No:80-SOLO7C-97-0001-01

All other brand and product names are trademarks of their respective holders. Actual contents may differ slightly from those shown in print. All specifications and designs are subjected to changes without any prior notice.

Before using, please read the manual carefully

MULTIMEDIA SPEAKER SYSTEM

 Important Safety Instructions



Caution:

TO reduce the risk of electric shock, do not dismantle the apparatus and do not expose the apparatus to rain or moisture. No user-serviceable parts inside. Refer servicing to qualified personnel.

Explanation of Graphical Symbols:

 The lightning flash within an equilateral triangle is intended to alert you to the presence of uninsulated “dangerous voltage” within the product’s enclosure that may be of sufficient magnitude to constitute an electric shock to persons.

 The exclamation point within an equilateral triangle is intended to alert you to the presence of important operating and maintenance (servicing) instructions in the literature accompanying the appliance.

WARNINGS:

1. Read Instructions—All the safety and operating instructions should be read before the appliance is operated.
2. Retain Instructions—The safety and operating instructions should be retained for future reference.
3. Heed warnings—All warnings on the appliance and in the operating instructions should be adhered to.
4. Follow instructions—All operating and use instructions should be followed.
5. Installation—Install in accordance with the manufacturer’s instructions.
6. Power sources—This product should be operated only from the type of power source indicated by the marking adjacent to the power cord entry. If you are not sure of the type of power supply to your home, consult your product dealer or local power company.
7. Grounding or polarisation—the appliance is not required to be grounded. Ensure the plug is fully inserted into the wall outlet or extension cord receptacle to prevent blade or pin exposure. Some versions of the product are equipped with a power cord fitted with a polarized alternating line plug (a plug having one blade wide than the other). This plug will fit onto the power outlet only one way. This is a safety feature. If you are unable to insert the plug fully into the outlet, try reversing the plug. If the plug should still fail to fit, contact your electrician to replace your obsolete outlet. Do not defeat the safety purpose of the polarised plug. When using an extension power-supply cord or a power-supply cord other than that supplied with the appliance, it should be fitted with the appropriate moulded-on plugs and carry safety approval appropriate to the country of use.
8. Power cord protection—Power-supply cords should be routed so that they are not likely to be walked on or pinched by items placed on or against them, paying particular attention to cords at plugs, convenience receptacles and the point where they exit from the appliance.
9. Overloading—Do not overload wall outlets, extension cords or integral convenience receptacles, as this can result in a risk of fire or electric shock.
10. Ventilation—The product must be properly ventilated. Do not place the product on a bed, sofa, or other similar surface. Do not cover the product with any items such as tablecloths, newspapers, etc.
11. Heat—The product should be situated away from heat sources such as radiators, heat registers, stoves, or other products)including amplifiers_ that produce heat. No naked flame sources, such as lighted candles, should be placed on the apparatus.
12. Wall or ceiling mounting—The product should be mounted to a wall or ceiling only as recommended by the manufacture.
13. Water and moisture—To reduce the risk of fire or electric shock, do not expose the product to rain, dripping, splashing or excessive moisture such as in a sauna or bathroom. Do not use this product near water—for example, near a bathtub, washbowl, kitchen sink, laundry tub, in a wet basement, or near a swimming pool and the like.
14. Object and Liquid Entry—Never push objects of any kind into this product through openings, as they may touch dangerous voltage points or short out parts that could result in a fire or electric shock. Never spill liquid of any kind on the product. Do not place any object containing liquid on top of the product.
15. Cleaning—Unplug the product from the wall outlet before cleaning. The cabinet of the subwoofer may be cleaned by dusting with a dry cloth. If you wish to use an aerosol cleaning spray, do not spray directly on the cabinet; spray onto the cloth. Be careful not to disturb the drive units.
16. Attachments—Do not use attachments not recommended by the product manufactures, as they may cause hazards.
17. Accessories—Do not place this product on an unstable cart, stand, tripod, bracket or table. The product may fall, causing serious injury to a child or adult, and serious damage to the product. Use only with a cart, stand, tripod, bracket or table recommended by the manufacturer or sold with the product. Any mounting of the product should follow the manufacturer’s instructions and should use a mounting accessory recommended by the manufacturer.
18. Moving the appliance—A product and cart combination should be moved with care. Quick stops, excessive force and uneven surfaces may cause the product and cart combination to overturn.

 Trouble Shooting

Troubles	Solution
Power LED won't light up	Check if the system is powered on
	Check the power plug well connected
No Sound	Check if the audio source is working well
	Check if the audio and speaker cables well connected
	Check if the volume at right level
One or more satellite no sound	Check if the satellite cable well connected
No Bass	Check if the Bass Volume at right level
Sound is distorted	Check if the volume at lower level
If the problem still exists, please contact the distributor or ask for professional service	

Technical Information

Features:

- *Designed for Multimedia PC, High Performance to Price Ratio.
- *Complete wooden box with elegant wooden finish make pure sounds, avoid sound mixture.
- *The system is magnetically shielded which can be put near the monitor or TV, and without magnetic influence.
- *The ultimate aim of Microlab R&D system is to inherit and carry forward the European musical culture style. To do this, all designs must be music-oriented and sourced from music and art. Having Microlab, you can enjoy European musical taste.

Specification

*Amplifier specification:

Power output	55Wx2 RMS
Frequency response	5Hz-70KHz
Sensitivity Input	440mV
Separation	≥55 dB
S/N	85dB

*Acoustic specification:

Frequency range	55 Hz-20KHz
Sensitivity	85dB
Driver unit:	6.5"x2 (magnetically shielded) +1"

*Audio input:

(Input 1) RCA jack
(Input 2) RCA jack
(L Speaker) screw terminal

*Audio output:

screw terminal

*Product size(DxWxH):

325x220x558mm

The apparatus is left unused for a long period of time.

20. Serving—Do not attempt to service this product yourself, as opening or removing covers may expose you to dangerous voltage or other hazards. Refer all servicing to qualified service personnel.
21. Replacement parts—When replacement parts are required, be sure the service technician has used replacement parts specified by the manufacturer or have the same characteristics as the original part. Unauthorized substitutions may result in fire, electric shock or other hazards.
22. Mains fuses—For continued protection against fire hazard, use fuses only of the correct type and rating. The correct specification for each voltage range is marked on the product.
23. Do not turn up the volume while listening to a section with very low level inputs or no audio signals. If you do, the speaker may be damaged when a peak level section is suddenly played.
24. The only means of completely disconnecting the product from the power supply is by removing the power cord from the wall outlet or the product. Either the wall outlet or the power cord entry to the product must remain freely accessible at all times while the apparatus is in use.
25. The socket-outlet shall be installed near the equipment and shall be easily accessible.

Unpacking the system

Unpacking:

- *Fold the carton flaps right back and invert the carton and contents.
- *Lift the carton clear of the contents.
- *Remove the inner packing from the product.
- ☺ We suggest you retain the packing for future use.

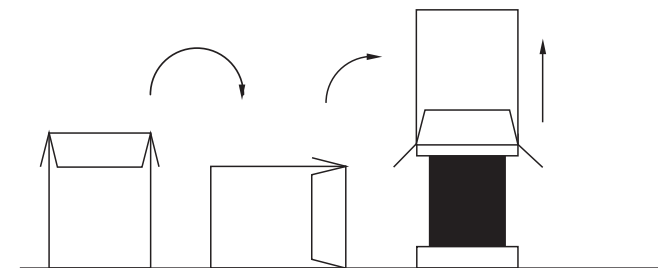

You should find following items while unpacking:

- R(main) Speaker 1pc
- L(sub) Speaker 1pc
- Remote control 1pc
- 3.5mm-2RCA signal cable 1pc
- Speaker cable 1pc
- User's manual 1pc

Function Instruction

***Front View**

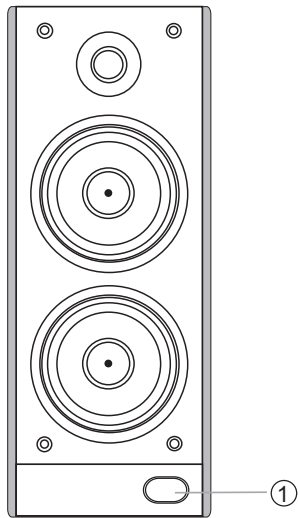

1. Remote Control Signal Receiving Window and digital display

***Front View of Remote control**

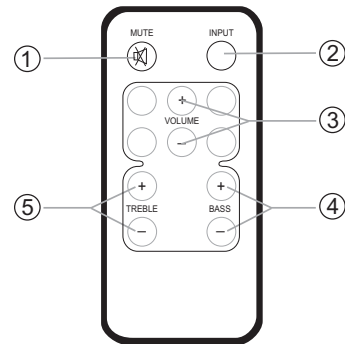

1. MUTE: press the key to make the system in muting
2. INPUT SELECT: press the key to select AUX or PC audio input
3. VOLUME +/- key: adjust the speaker system's volume, press the key to your demanding level
4. BASS +/-key: adjust the bass volume, press the key to your demanding level
5. TREBLE +/-key: adjust the treble volume, press the key to your demanding level

***Back View**

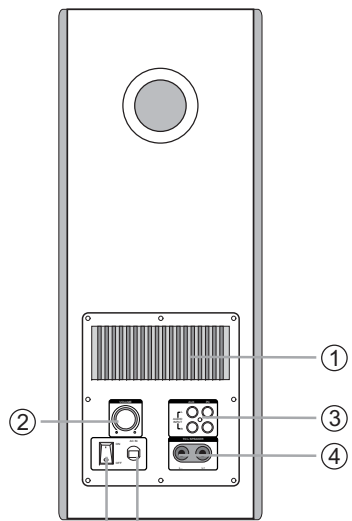

1. HEAT SINK
2. VOLUME CONTROL
Adjust the speaker system's volume to your demanding level
3. AUDIO INPUT
2.0 channel signal input jack
4. AUDIO OUTPUT
To L speaker
5. POWER
Press the switch ON or OFF
6. POWER CORD

System Connection

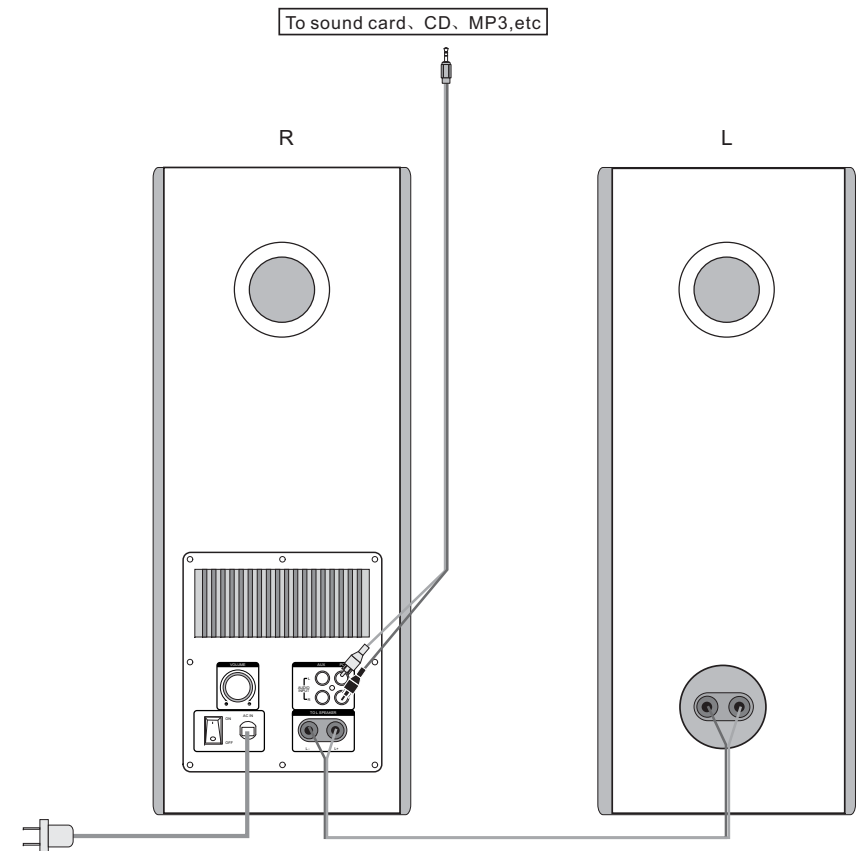

1. Connect one end of the translucent speaker cable to the audio input screw terminal on the back of the sub speaker. the golden wire connect to red screw terminal. the silvery wire connect to black screw terminal, the other end to the L-speaker Audio output screw terminal on the back of the main speaker.
2. Connect the RCA plug of the signal cable (one end with RCA plug, the other end with 3.5mm stereo plug) to the audio input sockets of the main speaker, the 3.5mm stereo plug to the audio output sockets of PC or other audio equipment.
3. While connecting to such as CD player, MP3 or PC, etc., please connect the signal cable to PC or other audio equipment Input; while connecting to such as VCD or DVD player, etc., please connect the signal cable to the AUX Input.
4. Make sure all the cable are connected correctly, then connect the power cord to AC outlet.